

Vermont Rivers & Roads Field Manual



Gilead Brook, 2011 Flood Recovery Work



Crossett Brook, 2015 Culvert Replacement Project

A Guide for Considering the River and Habitat in
the Design, Construction and Maintenance of
Transportation Infrastructure in Vermont

~ 2016 ~

Information Resources

- ◆ River Management Engineer Districts: http://dec.vermont.gov/sites/dec/files/wsm/rivers/docs/RME_districts.pdf
- ◆ Rivers and Roads Training Program Materials <http://dec.vermont.gov/watershed/rivers/river-management#training>
- ◆ ANR River Management Engineer and Permit Information <http://dec.vermont.gov/watershed/rivers/river-management#rules>
- ◆ Authorizing Emergency Protective Measures Guidance <http://dec.vermont.gov/watershed/rivers/river-management#municipal>
- ◆ Emergency Protective Measure Online Reporting Form <https://anrweb.vt.gov/DEC/StreamAlts/RequestEmergencyRME.aspx>
- ◆ USGS Stream Stats Tool <http://water.usgs.gov/osw/streamstats/Vermont.html>
- ◆ ANR Natural Resources Atlas <http://anrmaps.vermont.gov/websites/anra/>
- ◆ ANR River Management Standard Principles and Practices <http://dec.vermont.gov/sites/dec/files/documents/wsmd-rv-standard-river-management-principles-practices-2015-06-12.pdf>
- ◆ Vermont Aquatic Organism Passage Information <http://vtfishandwildlife.com/cms/One.aspx?portalId=73163&pageId=1763294>

Contents

Introduction	1
River Equilibrium	1
Building River Stability Into Road Repair and construction Projects	2
Determine the Expected Condition	4
• Drainage Area and Watershed Condition	
• Valley Setting and River Morphology	
• Bankfull Channel Dimensions Table	
• Planform Geometry	
Determine the Existing Condition	10
Identify Channel Adjustments and Evolution Stage	21
Design the Restoration.....	25
Structures	29
Stream Crossings	44

Introduction

Throughout Vermont; roads and other investments are located in narrow valleys alongside rivers. The longevity of these investments requires stable landforms. Rivers on the other hand are dynamic features of the landscape that naturally move over time. In many locations throughout Vermont the dynamic nature of rivers has been exacerbated by both natural and human caused disturbances. The result has been an increase in river instability which in combination with increases in severity and frequency of precipitation events is driving increased flood related damage and costs to transportation infrastructure and other investments. This field manual is a guide to understanding river instability and its causes and using that understanding to design transportation infrastructure projects that restore river stability for the sake of the infrastructure and the natural resource values of the river.

River Equilibrium

Rivers transport water sediment and woody debris. Over time, the erosion and deposition of sediment and debris result in an equilibrium channel shape (i.e., morphology). The equilibrium channel shape results in flow characteristics such that the flow is just powerful enough to transport the sediment and debris and the amount of erosion and deposition is minimized. As natural and human disturbances disrupt the balance between the

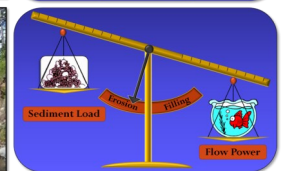
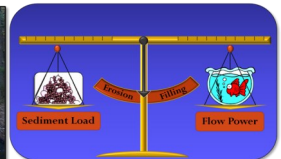
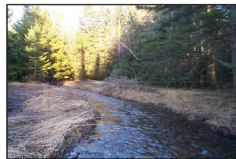

Rivers in equilibrium maintain a stable channel size (top). Rivers in which the sediment load overwhelms the flow power fill in over time (middle). Rivers in which the flow power is greater than necessary to move the sediment load enlarge over time (bottom)

Introduction

power of the flow and the burden of the sediment and debris, the channel form will adjust until a new equilibrium condition is eventually established.

Channel alterations change the balance between the flow power and channel resistance. When flow power is increased by activities such as narrowing or steepening the channel, rates of erosion increase. When resistance is reduced by removing roughness elements such as large boulders or meander bends erosion again increases. By evaluating proposed river and floodplain alterations with consideration to their impacts on river equilibrium we can better design, build and maintain riverside infrastructure in a manner that facilitates the equilibrium process; reduces river instability and increases the longevity of riverside investments.

Building River Stability Into Road Repair and Construction Projects

When restoring flood damaged infrastructure it is critical to understand the type and scale of river instability that caused the infrastructure damage. Damage at a particular site might be related to larger scale channel adjustments that aren't apparent at first look. For example, a road embankment failure caused by channel widening may actually have been the result of widespread (i.e., systemic) channel bed erosion (i.e., channel incision) that was initially triggered by over dredging done thirty years ago.

Every river has an expected equilibrium condition that is largely dictated by its valley setting. For example, rivers in flat broad valleys are expected to meander whereas rivers in steep narrow valleys are expected to be straighter. River instability can be understood by comparing the expected equilibrium condition to the existing condition.

Introduction

Whether confronted with one-time localized flood damages or recurring systemic problems, the following steps can be used to understand the instability and rebuild the infrastructure in a manner that maximizes river and infrastructure stability into the future:

1. Determine the expected morphology.
2. Determine the existing morphology.
3. Compare the expected morphology to the existing morphology to identify Channel Adjustments and Stage of Channel Evolution.
4. Develop a conceptual design that moves, or allows natural processes to restore the equilibrium condition to the greatest extent possible.
5. Where stream alterations or structural treatments are required use practices provided in this manual and Vermont River Management Standard Practices and Principles.

Reading the river is not an exact science. Nature is messy and often unmeasurable. Judgement is often required. Remember that no one piece of information you gather or judgment you make will by itself provide you a clear answer to particular question. The trick is to gather as much information as possible and select the answer that is most strongly supported by that information. Decisions based on multiple pieces of information and an understanding of river processes will result in more resilient rivers and transportation infrastructure on the whole.

Expected Condition

Determine the Expected Condition

Determine the expected (i.e., equilibrium) condition of the river by measuring the following valley and channel characteristics.

- Channel Width and Depth: depend primarily on the amount of **drainage area** for the site. Use the USGS Stream Stats or Vermont ANR Natural Resources Atlas tool to measure the drainage area. Look up the drainage area and corresponding width and depth in the Vermont Bankfull Channel Dimensions table on the next page to determine the expected bankfull width and depth of the river.

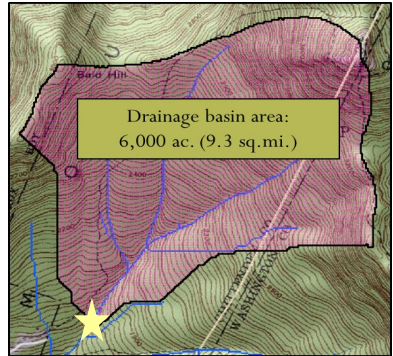

Drainage area is the area of land that delivers runoff to a given point of the river.

- Confinement Ratio: is the extent to which the valley confines the channel and is calculated as the valley width divided by the channel width. Measure valley width from a topographic map and use channel width determined in the previous step.

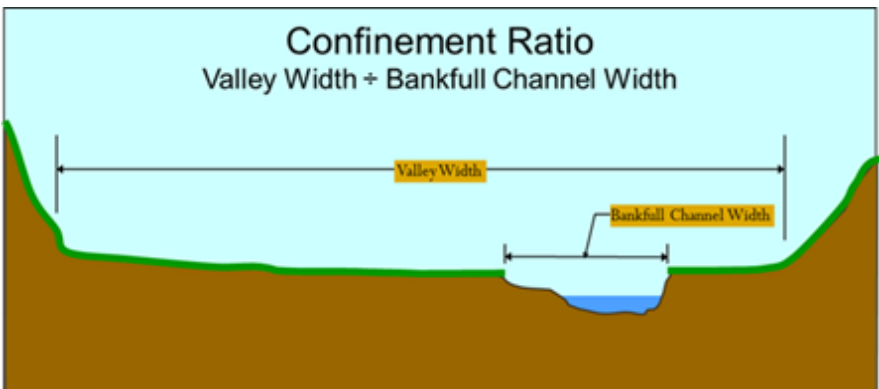

Confinement Ratio is the valley width divided by the channel width.

Expected Condition

Vermont Bankfull Channel Dimensions Table

Drainage Area (mi ²)	Bankfull Width (ft.)	Bankfull Depth (ft.)	Drainage Area (mi ²)	Bankfull Width (ft.)	Bankfull Depth (ft.)
0.5	10	0.8	42	68	2.9
1	13	1.0	46	71	3.0
2	18	1.2	42	68	2.9
3	21	1.3	46	71	3.0
4	24	1.5	50	73	3.1
5	27	1.6	55	76	3.2
6	29	1.6	60	79	3.3
7	31	1.7	65	82	3.4
8	33	1.8	70	85	3.4
9	34	1.9	75	88	3.5
10	36	1.9	80	90	3.6
12	39	2.0	85	93	3.6
14	42	2.1	90	95	3.7
16	44	2.2	95	97	3.8
18	47	2.3	100	99	3.8
20	49	2.4	105	102	3.9
22	51	2.4	110	104	3.9
24	53	2.5	115	106	4.0
26	55	2.6	120	108	4.0
28	57	2.6	125	110	4.1
30	59	2.7	130	112	4.1
34	62	2.8	135	113	4.2
38	65	2.9	140	115	4.2

*Width = $13.1 \times \text{D.A.}^{0.44}$ ($R^2 = 0.91$); Depth = $0.96 \times \text{D.A.}^{0.30}$ ($R^2 = 0.87$).

*Drainage area can be measured using the U.S. Geological Survey Stream Stats Tool at <http://streamstats.usgs.gov/Vermont.html>

*Values in red are extrapolations and should be used with caution and confirmed by on-site investigation.







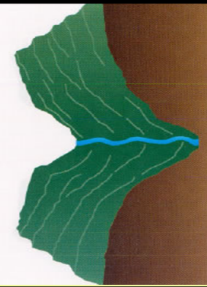

Use the Vermont Bankfull Channel Dimensions table to determine the approximate expected width and depth of the channel. Steep rivers tend to be slightly wider and flat rivers tend to be slightly narrower than values predicted by the tables.

Expected Condition

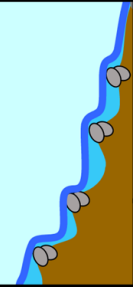
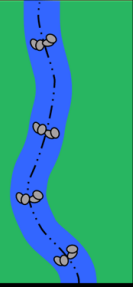
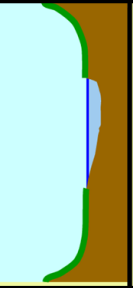
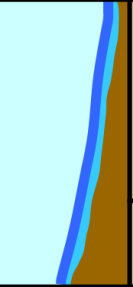
- **Valley Slope:** is the change in elevation from the upstream end of the valley to the downstream end of the valley divided by the length of the valley. For your project reach, use the topo-map to read the change in elevation from the top to the bottom of the valley and divide by valley length to determine slope.
- **Valley Setting:** Use the confinement and valley slope values you've measured to select the valley setting from the Valley Setting and Channel Morphology table on the next page. Once you've identified the valley type you can use the table to determine the expected values for the three following channel characteristics.
 - **Width Depth Ratio:** is the ratio of channel width to channel depth.
 - **Bedform and Material Size:** Bedform describes the type of vertical undulations of the bed and are important for energy dissipation and habitat. Material size summarizes the median size of the particles making up the bed and banks.
 - **Sinuosity:** is the ratio of the channel length to the valley length and affects channel slope, energy dissipation and habitat.
- **Planform Geometry:** Rivers in moderate and broad valleys that are not controlled by bedrock typically have well developed meanders. Planform geometry describes several aspects of a meander's shape (see figure below).
 - **Belt Width:** is the cross-valley distance from the outside bank of a meander bend to the outside bank of the opposite meander bend.
 - **Wavelength:** is the straight line distance of one full meander cycle.

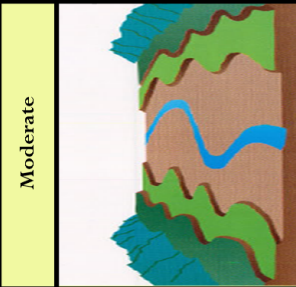
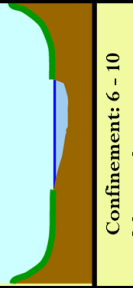
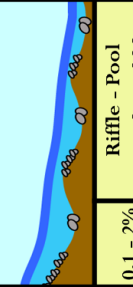
Expected Condition

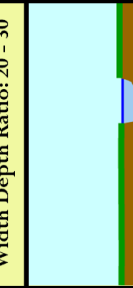
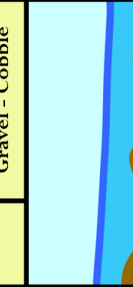
Valley Setting and Channel Morphology Table

Valley Type	Cross Section	Slope - Bedforms	Planform
 <p>Steep - Narrow</p>	 <p>Confinement Ratio: 1 - 4 Width Depth Ratio: 12 - 20</p>	 <p>3% min. Cascade/Step - Pool Cobble - Boulder</p>	 <p>Sinuosity: 1.2 max.</p>
	 <p>Confinement Ratio: 4 - 6 Width Depth Ratio: 12 - 30</p>	 <p>1 - 3% Plane Bed Gravel - Cobble</p>	 <p>Sinuosity: 1.2 max.</p>
 <p>Moderate</p>	 <p>Confinement: 6 - 10 Width Depth Ratio: 20 - 30</p>	 <p>0.1 - 2% Riffle - Pool Gravel - Cobble</p>	 <p>Sinuosity: 1.2 - 1.5</p>
	 <p>Confinement Ratio: 10 min. Width Depth Ratio: 12 max.</p>	 <p>0.1 % max. Ripple - Dune Silt - Sand</p>	 <p>Sinuosity: 1.5 min.</p>

Expected Condition

- **Radius of Curvature:** is the radius of the circle that would fit over an individual bend. The primary measures of planform geometry and their expected values are shown in the figure below. Use the expected bankfull width with the equations shown below to calculate the expected planform geometry.

Planform geometry can change regularly and such changes

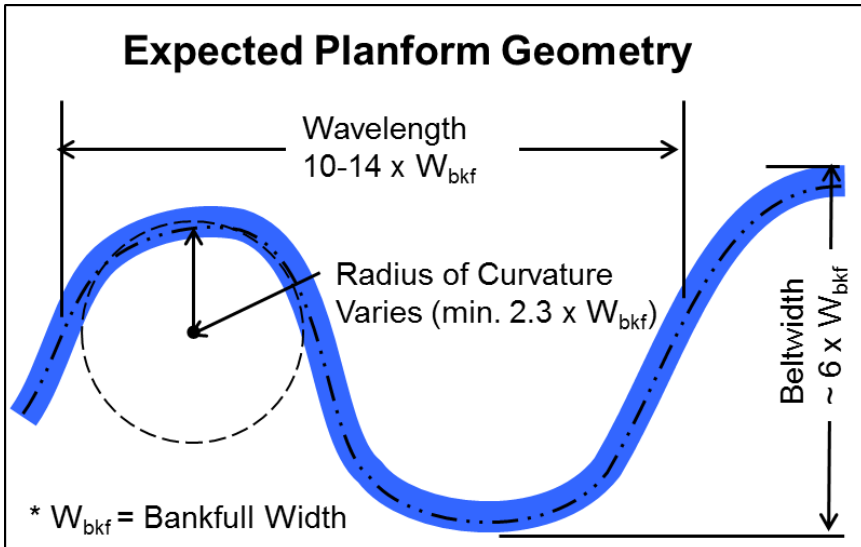

don't necessarily indicate serious instability as long as the river isn't incised (down-cut). However, comparing the existing to the expected planform geometry can confirm your suspicions about things such as historic channel management and inform your understanding of ongoing and future channel adjustments.

Expected Condition

Section Summary

You now have an image of the rivers expected equilibrium condition. This image will serve both as a baseline against which to compare the existing condition in order to understand the ongoing adjustments and a blueprint for what the river would ideally look like after the infrastructure is repaired. In reality, the river may not have been in its equilibrium condition prior to the infrastructure being damaged and returning it to that condition may not be realistic. Nonetheless, the image you have developed of the river's expected condition provides you a target to shoot for in rebuilding the river to as stable a condition as possible.

Expected Condition Information Form	
Parameter	Value
Confinement Ratio	5
Valley Slope (%)	1
Valley Type	Moderate
Bankfull Width (ft.)	44
Bankfull Depth (ft.)	2
Width Depth Ratio	22
Incision Ratio	1.0 – 1.2
Bedforms / Material Size	Riffle – Pool / Gravel
Sinuosity	>1.2
Beltwidth (ft.)	270
Wavelength (ft.)	540
Curvature Radius (ft.)	>103

Example of measurements of the expected morphology. These measurements will be used in the restoration design.

Determine the Existing Condition

Once the equilibrium condition has been determined, the next step is to measure the existing condition on the ground.

- Assess the Big-Picture: A river's morphology is a reflection of processes that occur throughout the entire watershed and over the course of its history. Considering historic impacts to the river will give you a head start in developing a sense of how the river is currently adjusting.
 - As little as a 5% increase in watershed impervious surface can lead to channel adjustments. View aerial photos to estimate the percent of impervious surfaces in the watershed.
 - Drainage channels increase the amount of water that reaches a river during a runoff event and generally leads to increased flows and channel enlargement. Use aerial photos and maps to get a feel for the density of the road and agricultural ditch networks in the watershed.
 - Historic channel management activities are often causes of channel adjustments. Channel management history may be difficult information to find. Sources of information may include local residents or Stream Geomorphic Assessment information available on the ANR Natural resources Atlas.
 - Past floods often trigger channel adjustments such as incision, widening or infilling. Review the flood history.



Example of an aerial photo showing significant impervious surface.

Existing Condition

- Sketch a Site Map: A site map sketch will help identify where to make morphology measurements, organize site information and communicate the situation to others. Make quick observations to locate the following features on the landscape.
 - The start and endpoints of the channel adjustment that caused the infrastructure damage. It is likely that the channel adjustment that damaged the infrastructure extend up and downstream of the damaged infrastructure.
 - The start and endpoints of the valley setting within which the adjusting river segment lies. Look for the locations at which the valley confinement and slope change significantly.
 - The start and endpoints of the restoration project. Addressing the entire length of the adjusting river segment is ideal. However, access and resource and time constraints may prevent you from addressing the entire adjusting segment. Develop an initial sense of the endpoints of the project and what the pros and cons of those endpoints are.

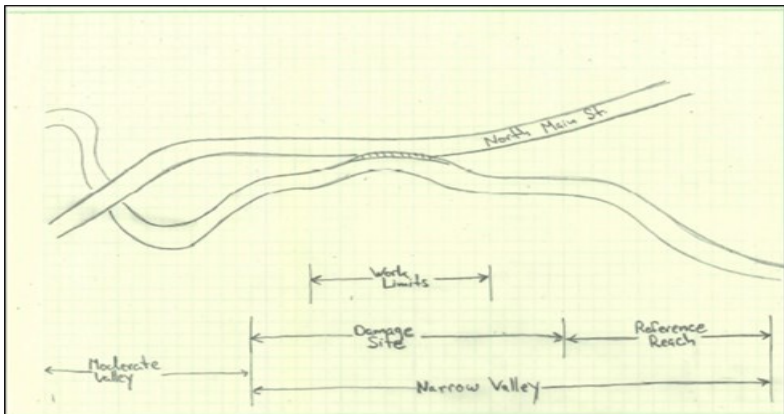

Example site map sketch.

Existing Condition

- **Confirm Valley Setting and Expected Morphology:** Use the field measured confinement and slope measurements to confirm that the valley setting determined previously was accurate. If the valley setting differs from the pre-determined setting use the Valley Type and Channel Morphology table to adjust the expected width depth ratio, bedform and material size and sinuosity values accordingly.
 - **Confinement:** Field check your previous confinement measurement. Measuring valley width can be difficult in the field without a range finder or survey equipment. A visual estimate of valley width is sufficient. Use the river width as your yard-stick and estimate how many channel widths could fit within the valley bottom. This is the confinement value.
 - **Valley Slope:** Survey the valley slope if possible. If survey equipment is not available assume the slope measured from the topo-map is correct unless your eye tells you otherwise.
- **Channel Morphology:** Measure the channel morphology within the project extent, the segments immediately up and down-stream of the project, and a reference reach. If the segments immediately up and downstream of the adjusting reach are in the same valley type and are in the expected equilibrium conditions than they will provide useful reference condition information. If they are not in the same valley type or are not in the expected condition the information will be helpful when determining how to tie the project into the up and downstream

Reference Reach

A stable reach with similar drainage area and in the same valley type can serve as a reference or blueprint for the recovery project. Measure the morphology of the reference reach to develop a blueprint for the recovery project.

Existing Condition

segments. If a reference reach does not exist immediately up or downstream of the adjusting reach locate a reference reach in the same valley setting with a similar drainage area (+ 10%) and as close by as possible.

- **Bankfull Width and Depth:** Bankfull width and depth are easily measured with a field tape and a level. Measure the bankfull width and depth at the elevation of the bankfull stage as shown below. Depth is measured at the average depth of the cross-section. See guidance on identifying the bankfull stage at the end of this section.

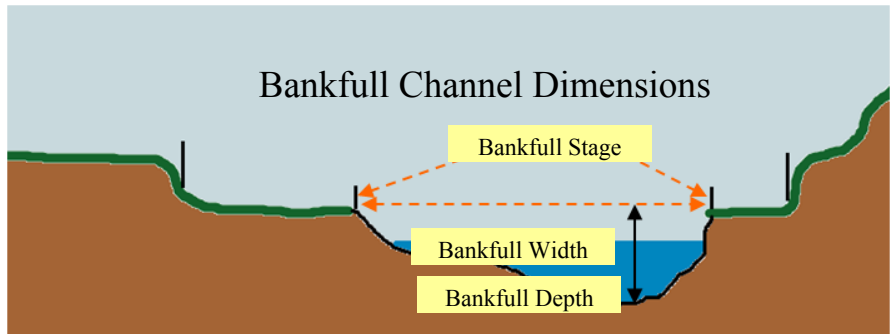

Measure bankfull width and depth at the elevation of the bankfull limits and compare to dimensions predicted by the channel dimensions table.

- **Incision Ratio:** Flooding is a critical energy dissipation mechanism that governs in-stream forces during high flow events. High river banks prevents erosive flows from being spilled onto the floodplain. The incision ratio describes the readiness with which flows can spread onto the floodplain. To calculate the incision ratio divide the height of the low bank by the bankfull depth. The incision ratio of a non-incised river will be one. The larger the ratio, the more severe the incision. Incision is moderate when the ratio is between 1.2 and 2.0, and severe when it is greater than 2.0.
- **Width Depth Ratio:** Bank erosion can be caused by channel widening or lateral channel movement. It can be difficult

Existing Condition

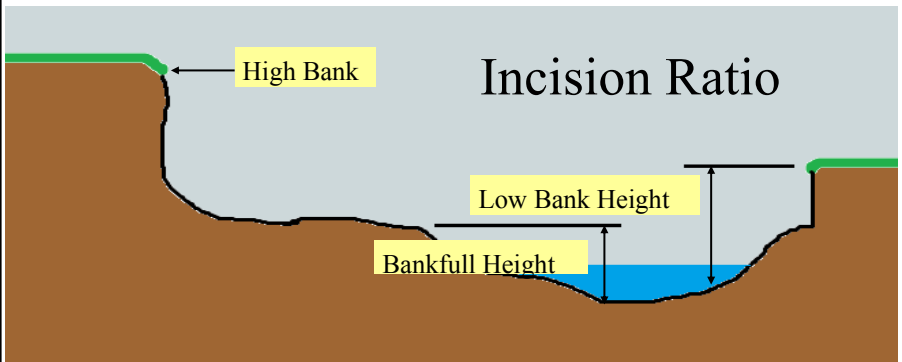

Incision ratio (I.R.) is calculated by dividing the height of the low bank by the bankfull depth.

to differentiate between channel widening and lateral movement. Channel widening will be indicated by a higher than expected width/depth ratio. Use your measurements of bankfull width and depth to calculate the width depth ratio.

- **Bed Forms and Material Size:** The presence or absence of bedforms can be a clue as to whether the channel is prone to incision or infilling. Generally, bedforms in channels adjusting to an increase in stream power may be completely or partially absent. Steps may be broken, with rocks missing from the step lines. Bedforms in infilling channels may be partially to completely buried. Pools may be filled in. Large point bars may be present.
- **Planform Geometry:** Planform geometry can be difficult and time consuming to measure in the field. However, significant planform geometry instability can be detected by simple observation. Estimate the field observed planform geometry measures you previously measured from maps and aerial photos.
- **Belt Width:** Belt width will become larger than predicted

Existing Condition

when the meanders of a river migrate laterally. Such lateral migration usually results from excess sediment supply that results in deposition on the point bars or the removal of vegetation on the outside bank of the meander bend. Belt width will become smaller than predicted in association with excess energy in the channel due to incision, channel straightening, and associated meander cutoffs.

- **Meander Wavelength:** A longer than expected meander wavelength in combination with other historic land use and channel management information can indicate historic channel straightening.



Example of straightening in what would be a meandering channel

- **Radius of Curvature:** A meander bend will become unstable and prone to both infilling and erosion when its radius of curvature is less than 2-times the bankfull channel width.
- **Vertical Instability Nickpoints and Grade Controls:** Nickpoints and Headcutting: A nickpoint is an overly steep erodible point of the streambed. Nickpoints mark the upstream end of an incised channel. As water flows over the nickpoint it removes particles from its face. As particles are removed from the nickpoint it may move in the upstream direction (i.e., headcut) for an uncertain distance. It is by this headcutting process that channel incision spreads from downstream to upstream. A clear indicator of a nickpoint is



Example of a nickpoint and associated downstream incision.

As water flows over the nickpoint it removes particles from its face. As particles are removed from the nickpoint it may move in the upstream direction (i.e., headcut) for an uncertain distance. It is by this headcutting process that channel incision spreads from downstream to upstream. A clear indicator of a nickpoint is

Existing Condition

taller banks downstream of the nickpoint where the bed has incised and lower banks upstream where the bed hasn't yet incised. Look for nickpoints as evidence of ongoing channel incision. Differentiate between nickpoints in recently deposited gravel bars from those in the native stream bed. Headcutting through recently deposited bars is the process of the river returning to the pre-deposit bed elevation and doesn't typically result in reach-scale instability.

- **Grade Controls:** Vertical instability can be controlled by structural features in the riverbed such as step features, large woody debris and bedrock. The effectiveness and longevity of the control is determined by its structural integrity. Channel spanning ledge is the most reliable grade control while a step comprised of mobile material is less reliable. Use judgment to evaluate the effectiveness and longevity of grade controls.



Example of old crib dam. A temporary grade control



Example of ledge falls. A permanent grade control

Existing Condition

- **Excessive Deposition:** Large rapidly growing bars and/or loose, unarmored bed material indicates an increased upstream sediment supply and/or a decrease in local sediment transport capacity. Deposition may cause increased likelihood of overbank flow and lateral channel migration.



Example of excessive sediment deposition driving planform

- **Age of exposed roots:** Freshly exposed roots are blonde in color and sharp and jagged. Older roots will be grey and smoother as a result of weathering. Fresh roots indicated recent erosion where older roots indicate older erosion.



Example of freshly exposed roots as a head-cut moves upstream

- **Bank Tree Lean and Trunk Curvature:** Leaning bank trees indicate the bank is failing. Curvature of the trunk indicates the tree has been leaning long enough to adjust its direction of growth toward the sun. The lower the point of curvature of a leaning tree, the longer it has been leaning.

Existing Condition

- **Trunk Flair:** Many tree species have a natural flair at the base of their trunk. Deposition around the base of a tree can be recognized by the lack of trunk flair. Buried tree trunks indicate areas of deposition and can be particularly helpful in identifying less evident long term deposition.



Example of trunk curvature

Section Summary

You now have a good picture of historic impacts to the river and the existing morphology of the damage site, the river segments immediately up and down stream of the damage site and the expected conditions (from either the remote sensing or in-field reference reach measurements). If the existing morphology matches the expected morphology and/or the reference reach morphology as measured in the field the channel is likely in a stable geometry. If not, the channel may be out of equilibrium and undergoing adjustments triggered by recent flooding or the longer term flood history and/or watershed scale alterations as discussed previously. The next section discusses how to compare the existing and expected morphologies to determine how the channel is adjusting and how those adjustments resulted in the infrastructure damage.

Existing Condition

Identifying the Bankfull Stage

- Bankfull Discharge is the discharge that shapes and maintains the channel over the long term. It is a moderate flow that is reached or exceeded every-other year on average, most commonly during spring runoff. Because it is both powerful and occurs fairly frequently, it moves more bed-load overtime than other flows.
- Bankfull Indicators are the flat depositional features (i.e., floodplain) that border the bankfull channel. They are formed by the bankfull discharge. Unlike the water surface elevation that is constantly changing, Bankfull indicators are static, thus they provide a consistent benchmark for measurement of width and depth of the channel. Bankfull indicator is synonymous with the Army Corps of Engineers' Ordinary High Water Mark.
- Look for the following bankfull indicators:
 - Flat benches and broad floodplain adjacent to the river bank. On straighter sections of river the bankfull stage is often marked by broad floodplain or the top of flat benches that protrude out from higher banks. The point at which the steep bank transitions to the flatter slope most often marks the bankfull stage.
 - Nearly flat and vegetated tops of stable point bars. On stable meandering rivers the tops of point bars usually mark the bankfull stage. Don't use the tops of large bars made up of coarse materials. These are often rapidly growing and don't provide good indicators of the bankfull stage.
 - Lower limits of trees. Because bankfull flow occurs fairly often most trees cannot grow within the bankfull channel. Do not use trees that have slumped into the channel over time.

Existing Condition

- Scour Lines. Scour lines can be made by many flows and ice and therefore not good bankfull indicators. Use scour lines only to support selection of other indicators.

Double Checking Bankfull Indicators

1. Find 3-5 bankfull indicators along the channel and measure the height of each above the water surface.
2. If the height of most of the indicators are within half a foot of each other, calculate their average. This is height, or stage, of the bankfull discharge from current water surface.
3. If the heights of the indicators are not within half a foot of each other continue identifying indicators until you find at least three that have the same height.
4. Use the bankfull stage above water surface as a benchmark for measuring bankfull width and depth of the channel.

Example Bankfull Indicators



Steep entrenched brook in a narrow valley



Moderate slope non-entrenched brook in a broad valley



Low gradient non-entrenched brook in a broad valley

Adjustments and Evolution

Identify Channel Adjustments and Evolution Stage

Damage to infrastructure is caused by channel adjustments (i.e., incision, infilling, widening, narrowing and lateral movement). Identifying the channel adjustments responsible for the observed damages is a critical step in the project design process. However, because a damage site may present evidence of multiple adjustments it can be tricky to identify the dominant adjustment responsible for the damage. The key is to think about adjustments with respect to the longer term channel evolution process.

Channel evolution is the long-term and predictable process that a river goes through once it is destabilized. Channel evolution models lay out the channel evolution process and help to see beyond the seemingly chaotic adjustment processes and focus on the heart of the instability. Once channel adjustments have been identified, placing them within the context of a larger scale and longer term channel evolution process provides

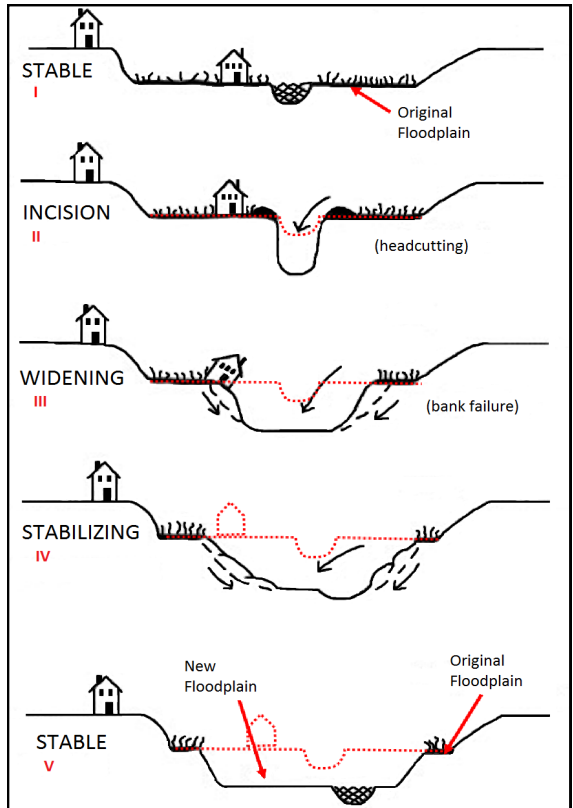

The Schumm evolution model explains how a channel will adjust in response to activities which trigger severe channel incision.

Adjustments and Evolution

Stages of Channel Evolution

Examples from Vermont

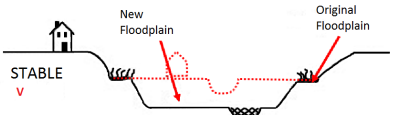
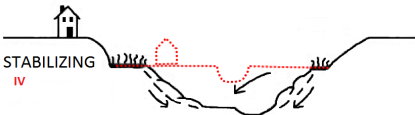
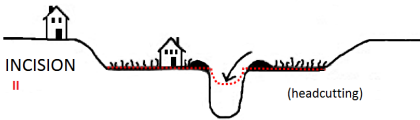
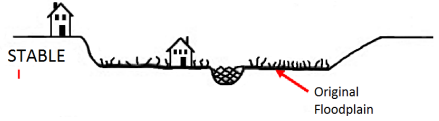

Adjustments and Evolution

insights as to why the channel is unstable and how the channel is likely to continue to adjust over time.

Compare the existing and expected or reference conditions to identify ongoing channel adjustments. Use the adjustments to help identify the stage of channel evolution to identify fundamental causes of adjustments and predict how the river is likely to adjust in the future.

Existing Expected and Reference Conditions					
Parameter	Expected Condition	Reference Reach	Damage Site	Adjustment	Stage of Channel Evolution
Confinement Ratio	5			N/A	
Valley Slope (%)	1			N/A	
Valley Type	Moderate			N/A	
Width	44	39	60	Widening	
Depth	2	1.5	3.5	Incising	
Width/Depth	22	2	17	Incising	
Incision Ratio	1.0-1.2	1.1	2.1	Incising	
Bedforms/Material Size	Riffle - Pool	Riffle - Pool	Riffles	Pool Filling	
Sinuosity	≥1.2	>1.2	≤1.2	Straightening	
Beltwidth	4 x W	4 x W	2 x W	Straightening	
Wavelength				Straightening	
Curvature Radius	2.3 x W	2.3 x W	3 x W		

Example data collection table. The expected and reference (i.e., expected) conditions are measured and compared to identify ongoing adjustments. The stage of channel evolution that would include all the identified adjustments is then selected.

Watershed scale and historic impacts discussed below can provide an explanation as to why the channel is adjusting in a particular manner and thereby confirm your conclusion about channel evolution.

- Think about spatial scale: Were the adjustments local such as scour around a boulder or systemic such as head-cutting caused by a lowering of the channel bed some distance downstream and likely to continue some distance up-

Adjustments and Evolution

stream? If the channel is infilling, where and how big is the source of the sediment?

- Forecast future adjustments and implications: Consult the channel evolution model and current stage of evolution to determine how the channel will continue to evolve. Think about time scale. How long have the adjustments you've identified been underway: months, years, tens-of-years or hundreds of years? Were there specific events such as floods or channel management that affected the rate of change? The historic rate of change will give you some perspective on likely continued rate of change.

Based on channel evolution models, stabilizing features, sediment sources and the severity of ongoing adjustments, how likely is it that the channel will continue to adjust in the future, how much and what will the consequences for local, upstream and downstream infrastructure be?

Section Summary

At this point you know what the upstream and downstream expected and existing conditions are. You also understand the adjustments that have led to the existing condition and have a reasonable understanding of likely future adjustments based on the channel evolution model. This understanding will help you to develop an infrastructure restoration design that addresses ongoing adjustments and either prevents the projected adjustments from occurring (for example, the removal of a large and mobile supply of sediment upstream of a crossing structure) or accommodates those adjustments (for example, an extra deep rip-rap key way to accommodate expected incision along a failed embankment).

Design

Design the Restoration

Any project that moves more than 10 cubic yards of instream material requires a stream alterations permit from an Agency of Natural Resources River Management Engineer (RME). However, in emergency situations with approval from the selectboard (See: Authorizing Emergency Protective Measures Guidance Document), work may be started prior to notification to a River Management Engineer. In such a situation where you are the primary project designer, use the information and steps laid out in this guidance and the Vermont Standard River Management Principles and Practices to develop and implement the recovery project.

Remember that in an emergency situation where no technical design assistance is available, the best approach for minimizing impact to channel stability and maximizing project efficiency is to do the minimal amount of work required to restore the functionality of the infrastructure that has been damaged. It is more efficient to conduct minimal work to implement a temporary restoration than to implement a complete rebuild only to learn that the project will need to be de-constructed and rebuilt because it is causing river instability.

At its core, the river design process is about understanding the expected or equilibrium condition of the river and developing an infrastructure design that accommodates that condition to the greatest extent possible, and where not possible using structural elements that will resist the erosional forces that are amplified by the infrastructure. The previous sections of this guidance have laid-out the process for understanding the expected condition of the river. Going forward, the design process is the same as it would be for infrastructure in other locations. Use what you have learned through trainings and reading this manual, give consideration to the design questions and general design strategies listed on the following pages to rebuild stability into the river and the infrastructure.

River Stability Design Considerations

1. Did the channel adjustment that damaged the infrastructure move the river away-from or toward equilibrium?
2. Is the river's ability to adjust in this manner during a flood critical to the river's ability to absorb flood energy, would elimination of this ability to adjust result in other more damaging adjustments?
3. Would returning the river to its pre-flood condition be a move toward or away from equilibrium.
4. Would reconstruction of infrastructure without regard to the river increase the likelihood of continued channel adjustments?
5. Can infrastructure be rebuilt in a manner that moves the river toward an equilibrium condition by restoring the morphology and function of natural equilibrium factors while also preventing infrastructure damage?
6. Can infrastructure be rebuilt in a manner that returns the river to the expected condition?
7. Would a "do nothing" alternative move the river toward equilibrium?

Design**General Design Strategies**

- Conduct the minimal amount of work required.
- First design the river and design the infrastructure around it.
- Restore the expected degree of floodplain connectivity to the greatest extent possible.
- Address vertical instability (Remember, even in emergencies, a RME consultation is required before armoring a streambed).
- Restore the expected or measured bankfull width and depth dimensions.
- Create smooth transitions to up and downstream reaches.
- Do not disturb the bed armor if at all possible.
- Maintain or construct bed features to provide roughness and habitat.
- Accommodate expected planform geometry to greatest extent possible.
- If stabilization structures are required, closely follow the design specifications provided in the next section and the Vermont Standard River Management Principles and Practices at : http://dec.vermont.gov/sites/dec/files/wsm/rivers/docs/SRMPP_1.3_lowres.pdf
- Follow the Stream Alterations Culvert Standards when replacing culverts to ensure preservation of sediment and flow transport and overall river stability and aquatic organism passage.
- Keep in mind the likely channel response to the activities listed in the table on the following page and try to avoid them.

Typical Channel Response to River and Road Maintenance Activities

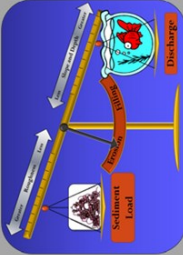
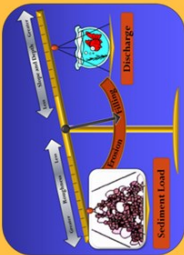
Activity	Resulting Change to Equilibrium Factors	Channel Response
Over Dredging	<p>↑ Increased Depth</p>	<p>Erosion</p> 
Over Dredging	<p>↑ Decreased Resistance & Sediment Volume</p>	
Channel Narrowing	<p>↑ Increased Depth</p>	
Channel Berming	<p>↑ Increased Depth</p>	
Channel Straightening	<p>↑ Increased Slope</p>	
Increased Runoff Rate	<p>↑ Increased Depth & Slope</p>	
Undersized Culvert	<p>↑ Decreased Slope Upstream</p>	<p>Filling</p> 
Channel Widening	<p>↑ Decreased Depth</p>	
Upstream Landslides	<p>↑ Increased Sediment Volume</p>	

Structures

The following structures are used to stabilize channels and in some instances enhance instream habitat. When technical assistance is not available use the information in this section and the Vermont Standard River Management Practices to design structures.

Stone Fill

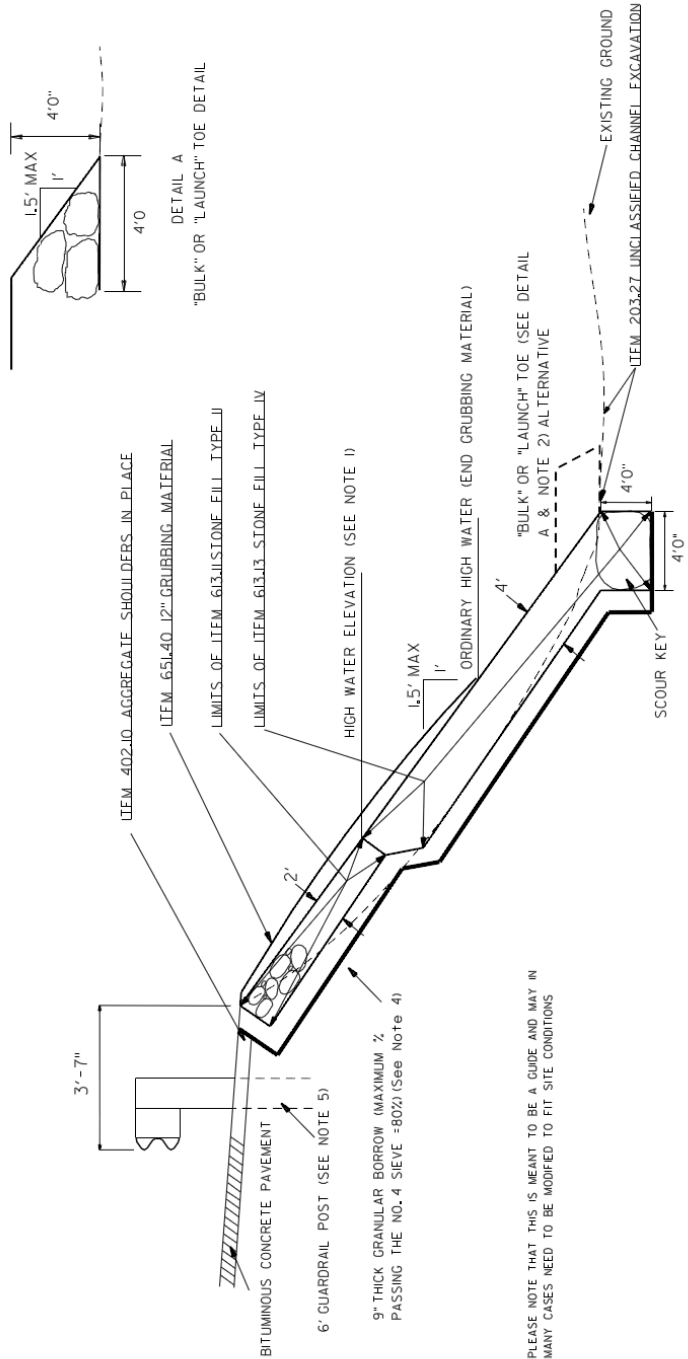

Figure 1. Stone Fill serves as an immobile surface that protects the underlying bank from erosion.

CONSIDERATIONS

- Slope
- Material Gradation
- Thickness
 - Keyway (vertical and lateral)
 - Top Elevation (1 ft above low floodplain on opposite bank or Q50)
- Underlayment/Bedding
- Maintaining Bankfull Width

STONE FILL SLOPE PROTECTION



PLEASE NOTE THAT THIS IS MEANT TO BE A GUIDE AND MAY IN MANY CASES NEED TO BE MODIFIED TO FIT SITE CONDITIONS

Structures

Placed Rip Rap Wall



Figure 2. A placed Rip Rap Wall creates lateral channel stability. The steep slope at toe results in less horizontal fill which allows for attainment of full bankfull channel width in confined settings.

NOTES

1. Stone toe wall shall be constructed with stones of the specified size and in no cases shall the immediate dimension of any stone be less than 3'0".
2. Wall shall be constructed with staggered (ie. running) joints between rocks on adjacent tiers.
3. Footer rock shall be embedded below the channel a minimum of 4'0". Stacked section shall have no more than 6'0" of exposure.
4. Contractor shall carefully select and place individual stones to maximize contact with adjacent stones. Stones are shown as blocks to give contractor the idea of what you would like. They do not need to be cut stone.
5. To extent practical, stones shall dip toward embankment to better resist sliding.

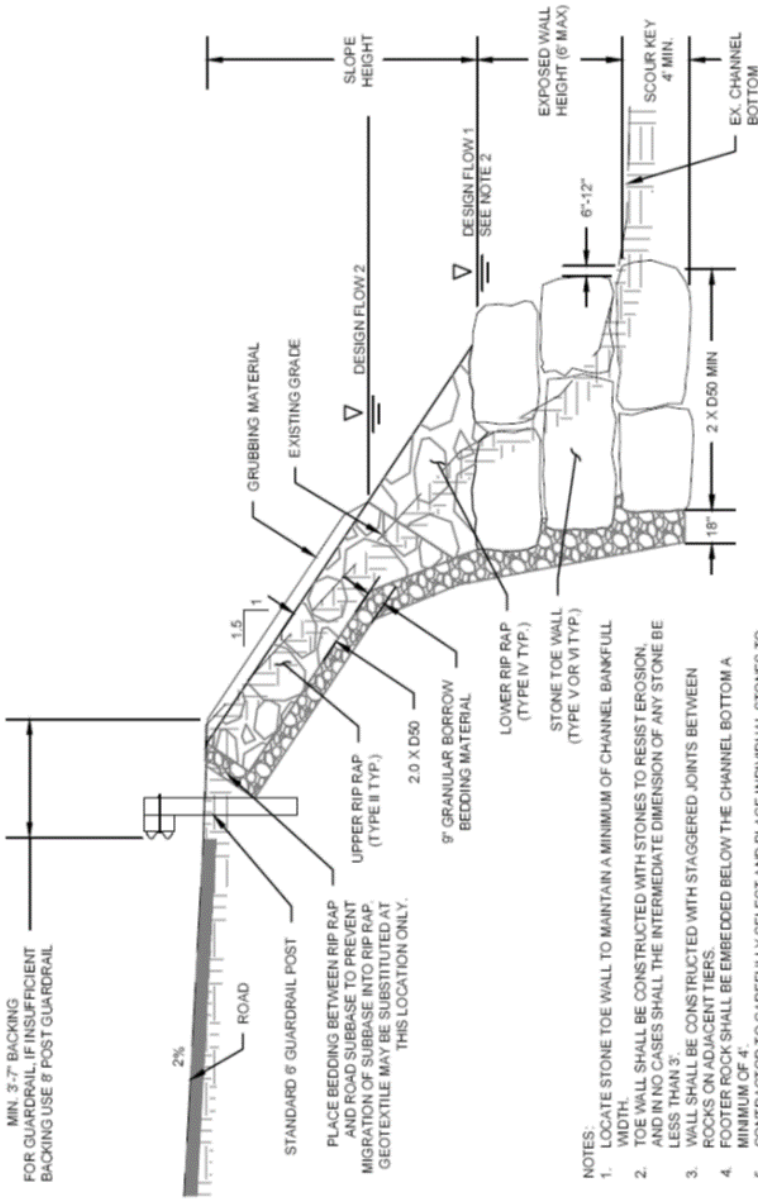

TYPICAL PLACED RIP RAP WALL SECTION

SCALE: 1" = 5'

Structures

Bed Armor



Figure 3. Bed armor creates an immobile surface to protect the underlying bed from eroding downward.

CONSIDERATIONS

- Channel Width and Depth
- Material Size and Gradation
- Thickness
- Up and Downstream Tapers into Channel Bed
- Availability of Bedload to Infill Gaps
- Assure Surface Flow (subsurface flow unacceptable)

NOTES

1. This practice must be overseen by an ANR River Management Engineer or their designee. Even in emergency situations.

Structures

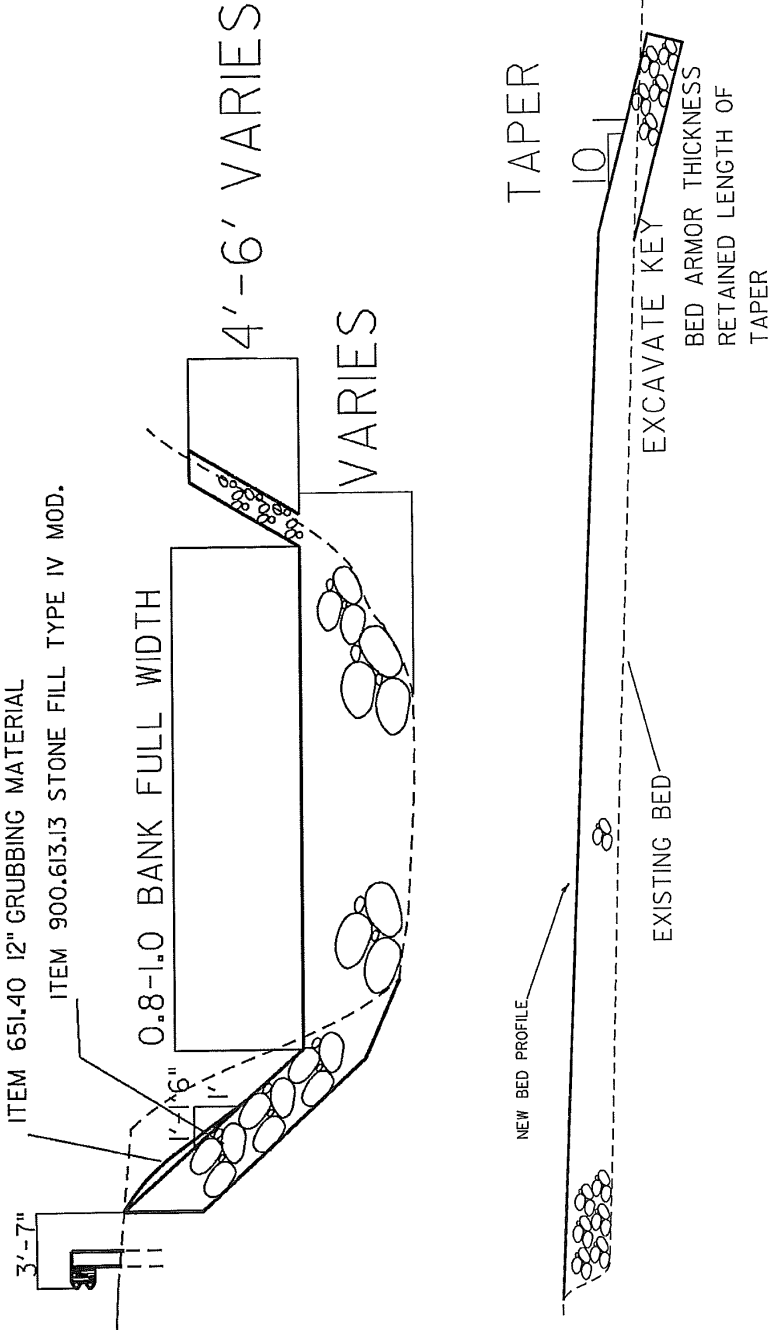

Structures

Rock Weir

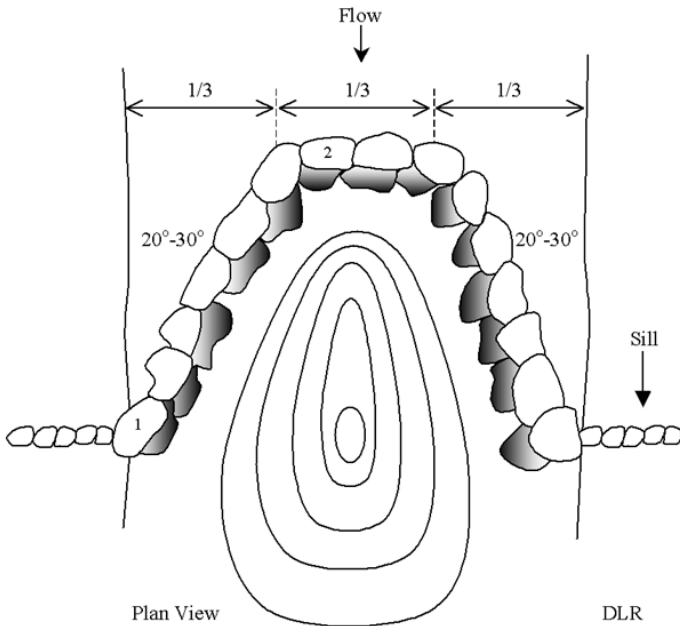
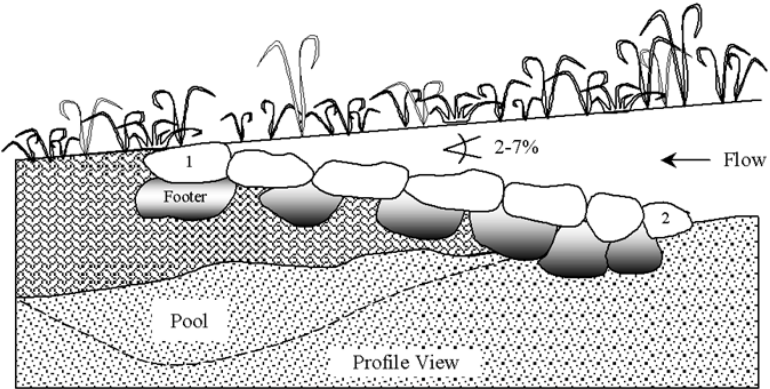
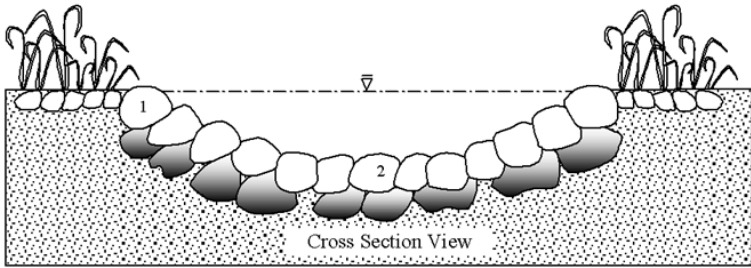

Figure 4. *Rock cross-vanes (looking upstream) meet multiple objectives including bed and bank stabilization and sediment transport by creating a stable point in the channel that dissipates and redirects erosive energy as well as habitat by providing deep pools.*

NOTES

1. Rock size should be in the range of 3-5 ft.
2. The footer depth should be 3 times the height of the protrusion of the invert rock (see page 41).
3. The top course should be offset slightly upstream of the footer course to protect against scour at the base of the structure.

Structures



Structures

Log Cross Vane



Figure 5. *Log cross-vanes are an alternative to the rock cross-vanes and meet the same objectives but can be more difficult to construct and have a shorter life expectancy. However, in situations where large rock is unavailable they can be a viable alternative to the rock cross-vane.*

NOTES

1. The invert of the structure is secured using a duck-bill anchor or placement of a large boulder on the ends of the logs.
2. Geo-textile should be used to prevent piping of sediments and undermining of the invert.

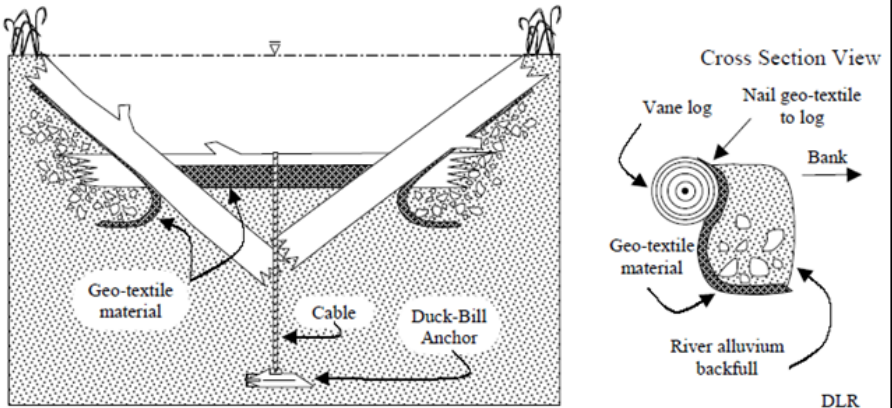
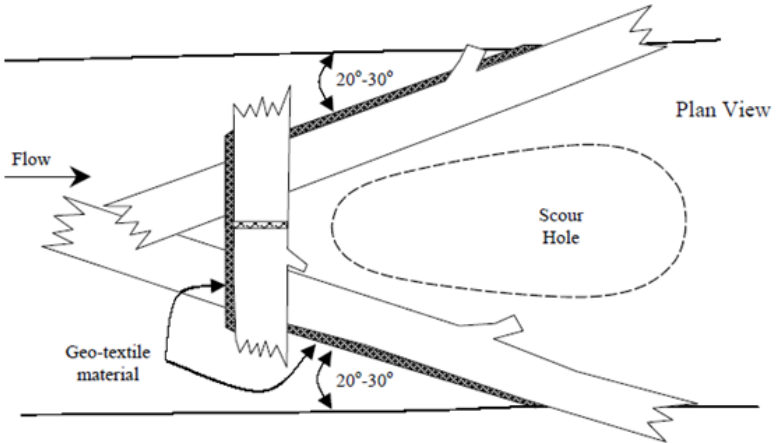
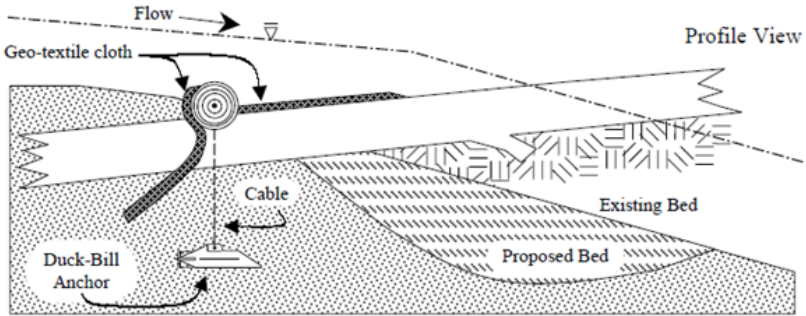

Structures

J-Hook Vane



Figure 6. *J-hook vanes meet multiple objectives including bank protection, sediment transport, channel capacity and habitat maintenance by dissipating and redirecting erosive energy into the center of the channel where a deep pool is created.*

NOTES

1. Rock size should be in the range of 3-5ft.
2. The footer depth should be 3 times the height of the protrusion of the invert rock (see page 30).
3. The top course should be offset slightly upstream of the footer course to protect against scour at the base of the structure.
4. Vanes can be constructed without the J-hook component.

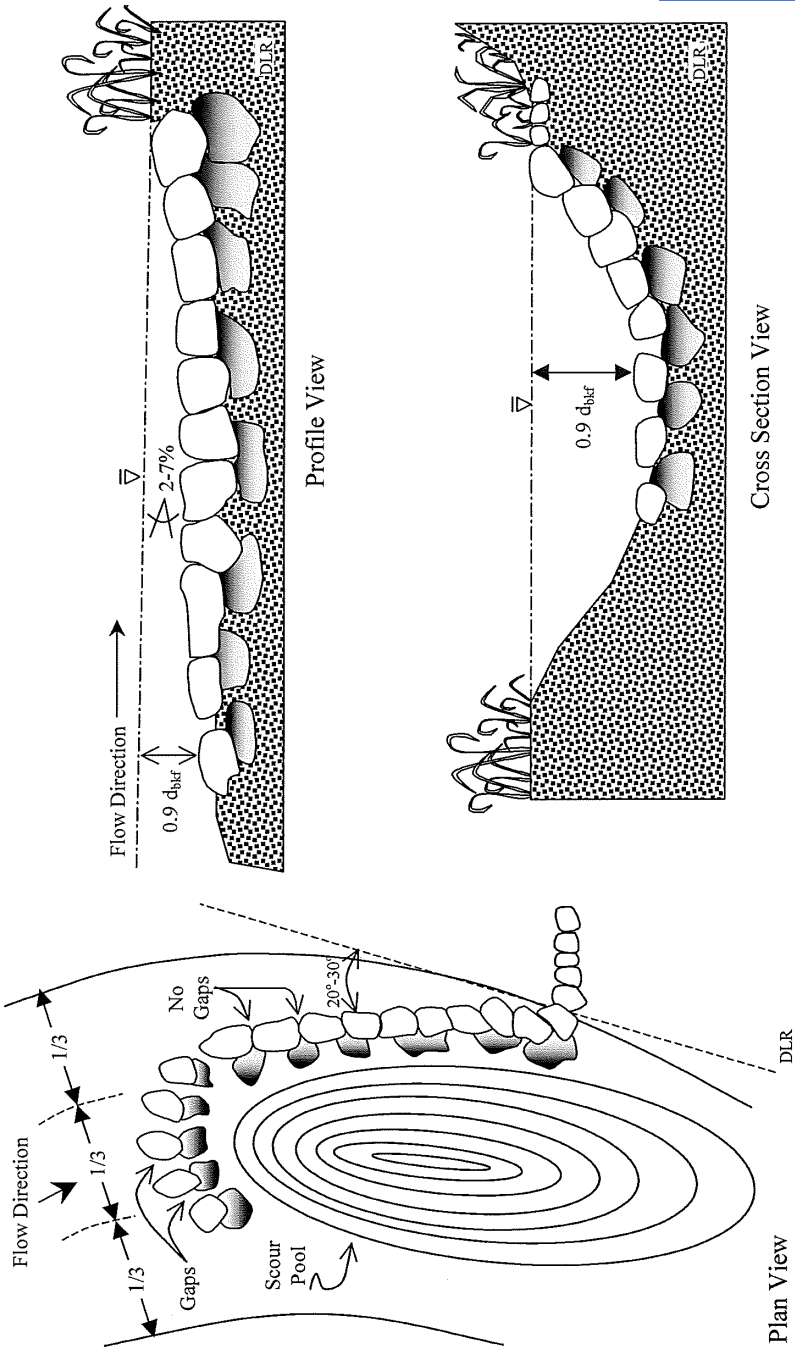

Structures

Rock Vane Structures: Footer Depth

For both the rock cross-vane and the J-hook vane the depth of the footer rock at the invert is 3 times the protrusion height (h) of the top invert rock (#2) in gravel and cobble bed streams. In sand bed streams the footer depth should be 6 times the protrusion height.

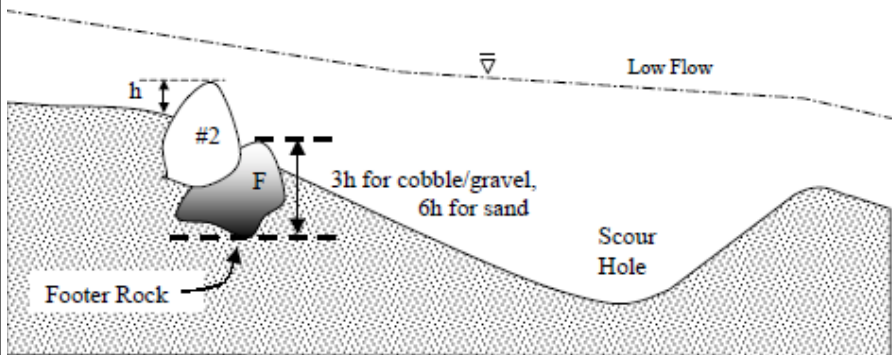

Log J-Hook Vane



Figure 6. Log J-hook vanes meet the same objectives as the rock J-hook vanes but can be more difficult to construct and have a shorter life expectancy. However, in situations where large rock is unavailable they can be a viable alternative to the rock J-hook vane.

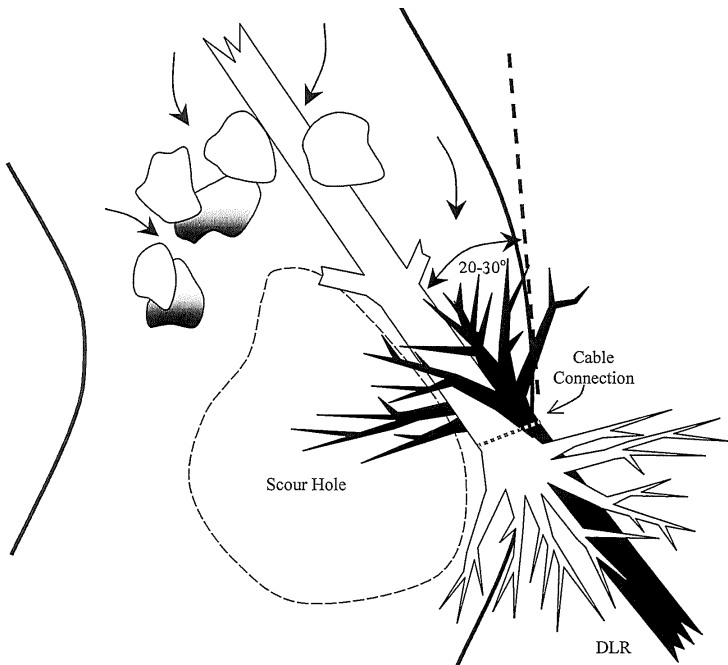

Structures

Random Boulder Placement



Figure 7. *Random boulder placement meets multiple objectives including channel stability and habitat maintenance by creating roughness that dissipates erosive energy in a way that results in the creation of small scour pools.*

NOTES

1. Boulder placements are suitable on streams where boulders would naturally occur but are absent.
2. Rock size should be 1 to 2 times the largest boulders that would naturally occur on the stream.
3. Clusters of 3 to 5 boulders with one boulder-width between boulders are most effective.
4. Boulders should occupy less than 10% of the bankfull cross-sectional area.

Stream Crossings

Stream Crossings

Culverts sized to the bankfull channel width with sufficient opening height and embedment depth, have a slope similar to the up and downstream channel and horizontally aligned with the channel, will have minimal impact on the hydraulics of the sediment transporting flows and therefore provide for natural channel stability and aquatic organism passage through the structure.

For more information on designing and retrofitting culverts for aquatic organism passage see the Vermont AOP Guidelines at: <http://vtfishandwildlife.com/cms/One.aspx?portalId=73163&pageId=1763294>

Vermont General Permit Culvert Requirements

Span Width	1 x W_{bkf}
Opening Height	4 x D_{bkf}
Embedded Depth	Greater of 30% of O.H., D_{84} or 18"
Profile	Match Channel Profile
AOP	Provided

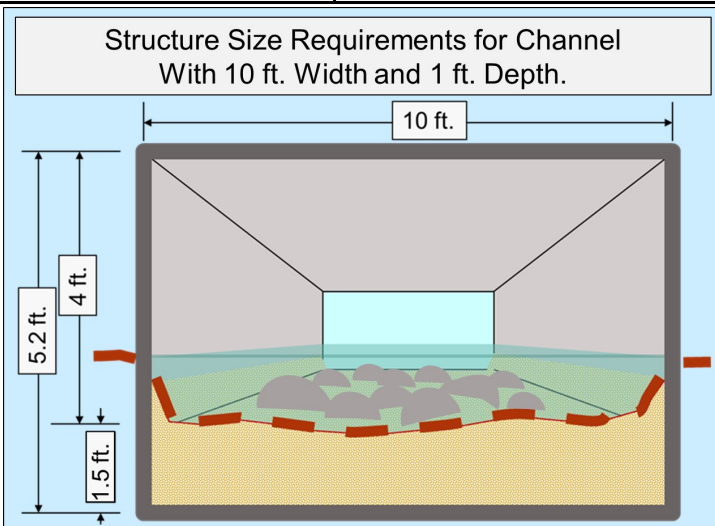

Prepared by the
Vermont Department of Environmental Conservation
in cooperation with the
Vermont Fish & Wildlife Department and
Vermont Agency of Transportation

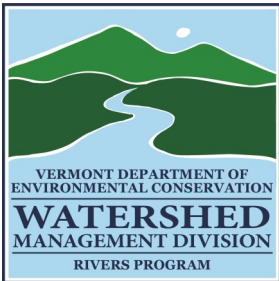

Field Manual Printing Made Possible
by the Generous Support of the
Lake Champlain Basin Program

